

INSTALLATION GUIDE

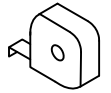

A

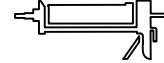
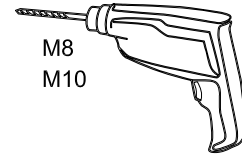
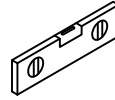
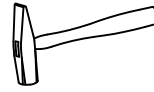
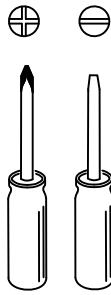
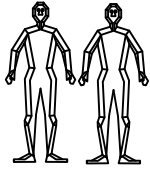
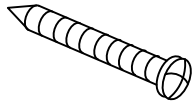

4 pcs

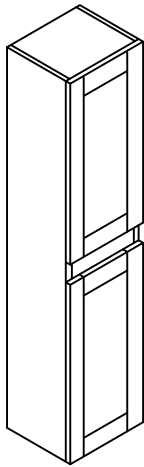
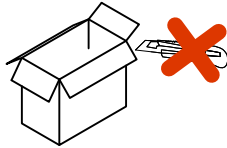

13.7"

WALL CABINET INSTALLATION

STEP 1: SELECT HARDWARE THAT IS BEST SUITED FOR YOUR WALL TYPE

IMPORTANT: USE "PAN HEAD" OR "ROUND HEAD" SCREWS WITH SEAT WASHERS. SEAT SCREWS TIGHTLY AGAINST BACK RAIL OR PANEL WITHOUT DRIVING INTO BACK RAIL OR PANEL MATERIAL.

PASO 1: INSTALACION DE GABINETES, SELECCIONE LA HERRAJERIA QUE MAS SE ADECUA AL TIPO DE SU PARED.

IMPORTANTE: USA TORNILLOS DE "CABEZA PLANA BISELADA" O "CABEZA REDONDA" CON ARANDELAS DE ASENTO. COLOCA LOS TORNILLOS FIRMEMENTE CONTRA EL PANEL O EL RIEL TRASERO SIN INSERTARLOS EN EL PANEL O EL RIEL

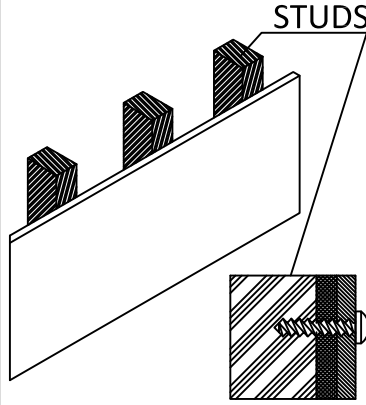

STUDS **STUDS:** Secure to wall with #10 x 3" screws at stud location. Locate at least 2 wall studs

MONTANTES: Fjelo a la pared con tornillos de # 10 x 3 pulgadas en los montantes.

Use at least 4 wall anchors when installing a 24" and 30" cabinet. Use at least 6 wall anchors when installing a 36" and 48" cabinet.

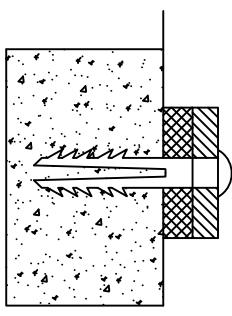

CONCRETE: Drill $\frac{1}{4}$ " holes, insert #10 wall anchors and secure to wall with #10 x 3" screws.

CONCRETO: Taladre orificios de $\frac{1}{4}$ pulgada, inserte anclas de expansión de #10 y fijelo a la pared con tornillos de # 10 x 3 pulgadas.

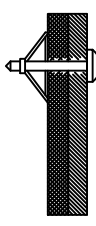

DRYWALL: Drill holes and secure to the wall with toggle bolts. Note: Use toggle bolts only when cabinet cannot be attached to a wall stud.

PANEL DE YESO: Taladre los orificios y fije la unidad a la pared con pernos acodillados. Nota: Use pernos acodillados sólo cuando el gabinete no se pueda fijar a los montantes de pared.

A=4 PCS

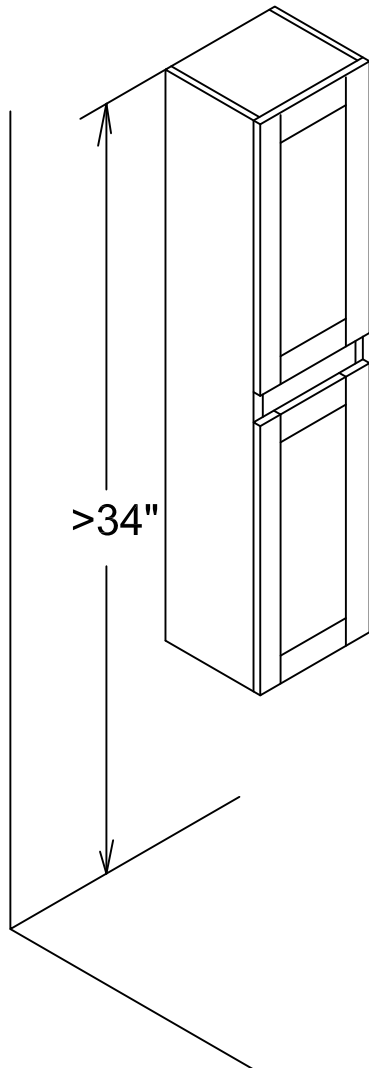
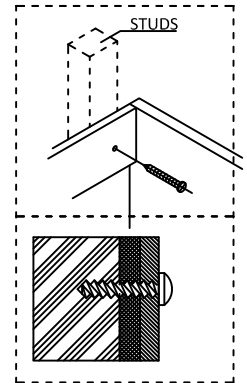
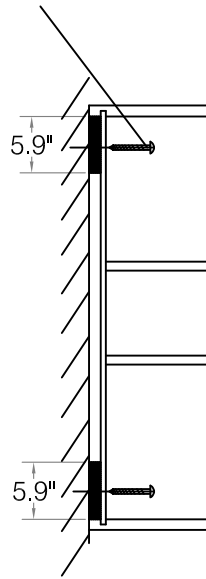

HINGE/DOOR ADJUSTMENT (IF APPLICABLE)

The door alignment was set in the factory, but it could have shifted during transit. If adjustment is needed, follow the instructions provided in chart below.

Las puertas estan alineadas de fábrica, pero pudieron haberse desalineado en el envío. Si es necesario alinearlas, recomendamos ajustar las puertas según se muestra en el siguiente diagrama

