

Notice

1. Opening and closing the door more gently to avoid the human error damage. Oil it every month to make it sliding smoothly.
2. Using Acid or alkali solution, knife to scrape the shower room are strictly forbidden.
3. Don't let the child or Persons with physical disabilities to take shower alone.
4. Don't climb the shower room or handing heavy things on it.
5. This board is Acrylic which will be turn soft when the temperature over 80 centidegreen, so, please keep below it. Suggestion let-out cold water before hot water.
6. Because the Acrylic surface hardness is similar like aluminium alloy, please notice the surface protect when pick-and-place it. Can use 2000# water polishing with nubuck leather, then use tooth paste with silk to make it flat when its damaged.
7. Under normal pressure of water it few to let water out when using it, should washing the faucet Valve often and check it if there is block of junk.
8. put on the silicon sealant in time in case of water leakage.
9. open the door to make it keep well-ventilated in case of any moisture to make the shower room get mildewed and produce of flavour.
10. used the Phillips screwdriver (3) to adjusting the vertical screws of the roof wheels, adjusting the sliding glass up or down, to make it in a suitable place.
11. If there is the phenomenon of the gap or down of the movable door , use a screwdriver or a hexagonal wrench transfer Pulley or hinge section to let the door up or down, to make it in a suitable place.
12. After installation, sealed the frame and tray basin gap place with silica gel. Then, use the neutral detergent to wash the aluminium frame and glass, to make it bright and clean.

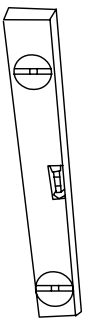

Track Level Bar

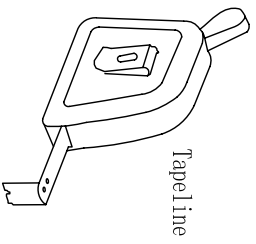

Tape line



Pencil



Ruler



Aiguille 3MM

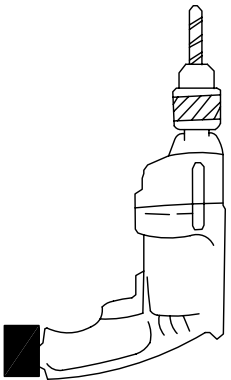

Electric Drill



Screwdrivers Blades

glass cement spear

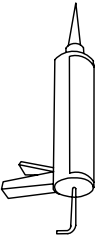

Screwdriver

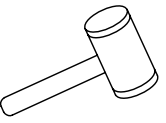
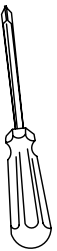







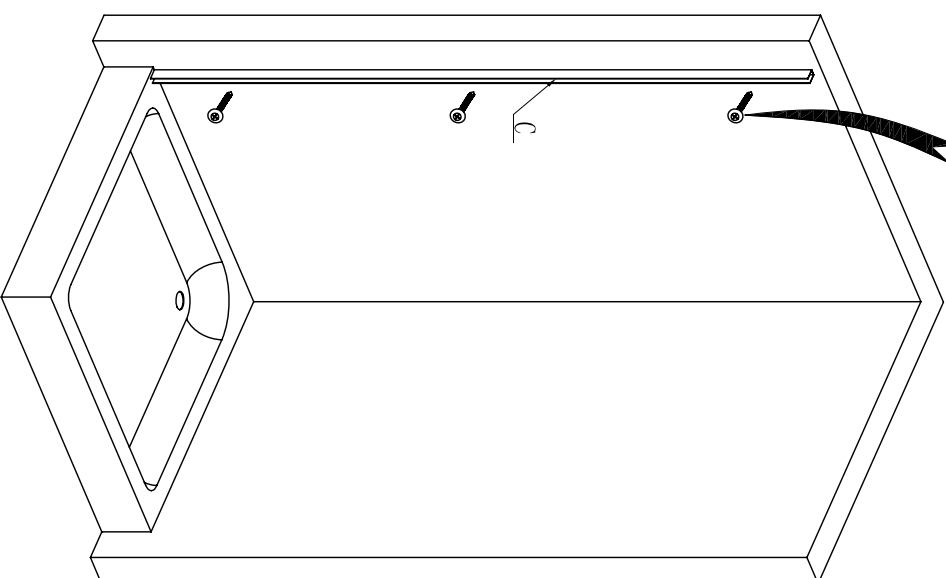
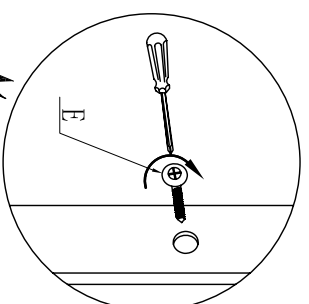

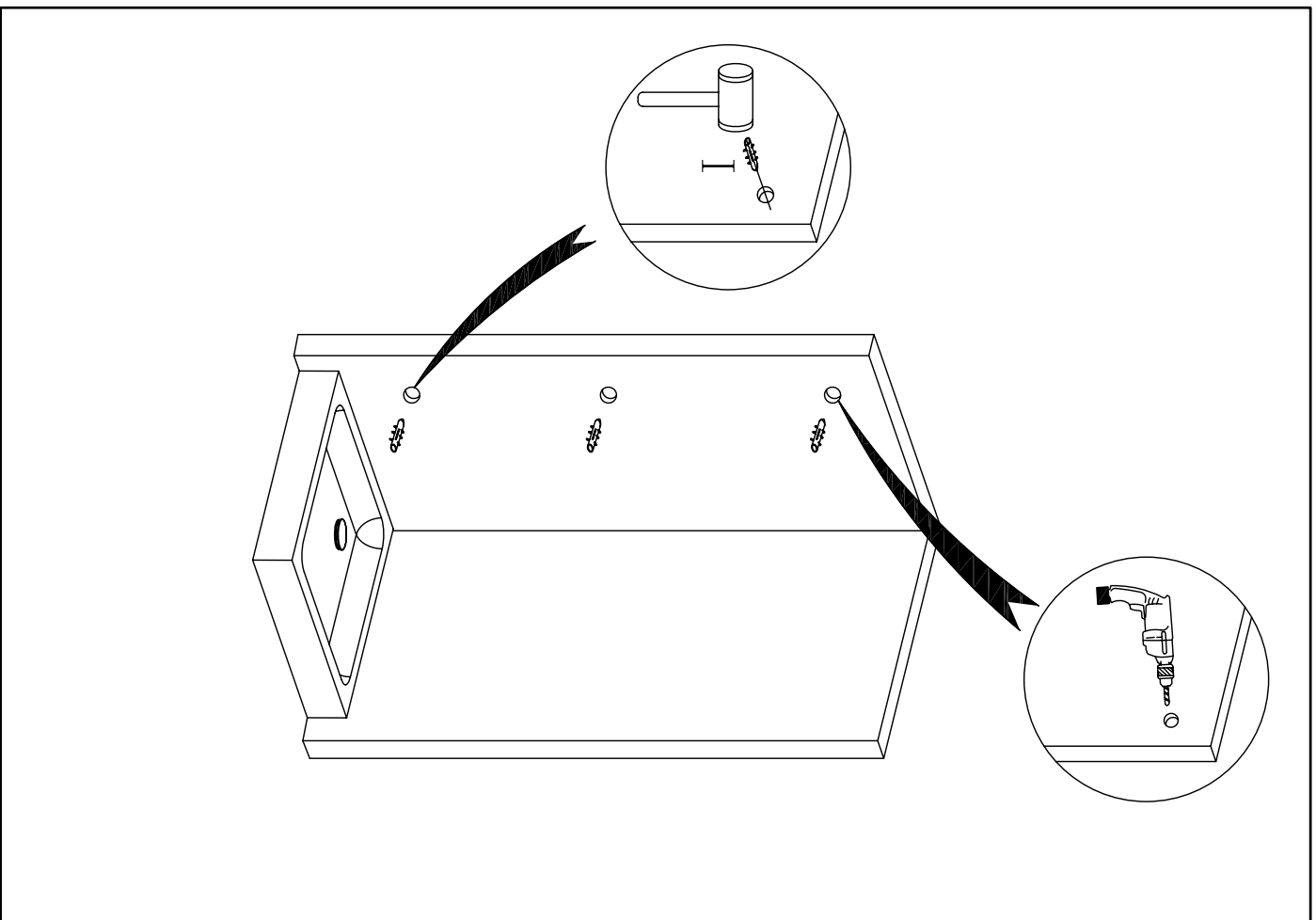

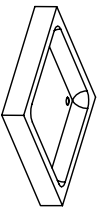
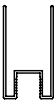
Rawhide Hammer

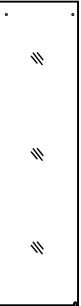
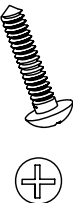

Wrench





spare parts				
Serial No.	Name	Rendering	Qty	
A	Shower tray basin		1	
B	Wall profile		1	
C	close-wall strip		1	
D	Fixed glass		1	
E	round head screwST4X30MM		4	
F	round head screwST4X12MM		3	
G	screw out-cup		3	
H	screw inner-cup		3	
I	Expansion Tub		4	
J	U style water-proof strip		1	
K	Drainage		1	
L	Flex their bands		1	

6

3

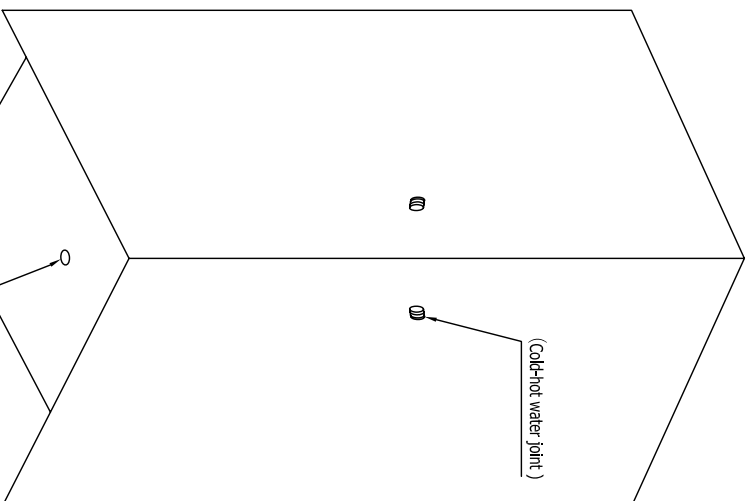

Introductions:

- 1、 This water-saving product should be better match with 6-8 L gas heater or 50L electric water heater
- 2、 the water pressure of this products should be within 0.1-0.4MPa, Out of Range would effect the normal use of it, can increase the water pump in case of the lower water pressure.

4

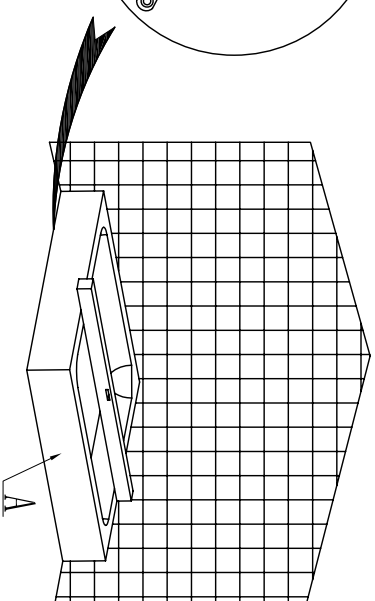
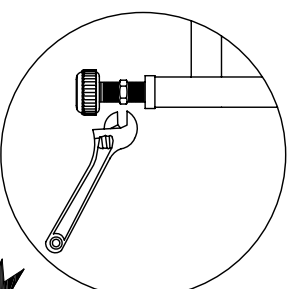
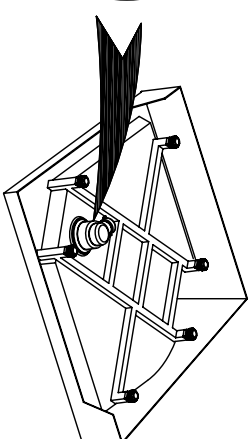
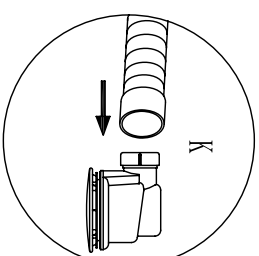

5

6

